

Application Note

Product: Minilyzer ML1
Subject: Signal Balance Error

This application note describes the signal balance error as measured by the Minilyzer ML1. It introduces the reader to the backgrounds and advantages of balanced audio signal transmissions, list abilities and benefits of the ML1 signal balance error analysis and explains how the signal balance error is calculated.

Contents:

1. Balanced / unbalanced connections
2. XLR connection, balanced signal
3. The signal balance measurement
4. Applications

Appendix:

- a. User manual signal balance error
- b. Calculation of signal balance error

1. Balanced / unbalanced connections

An unbalanced connection is a two-wire system. Of course both wires transmit the audio signal but one - called shield - reduces interference of external fields on signal transmission to a great extent. This shield normally is connected to ground.

A balanced connection is a three-wire system. Two wires carry the signal - one in original polarity one in inverted polarity - the third is the shield, which as with unbalanced connections normally is connected to ground.

The balanced system is more immune to noise, and is by far the preferred method in professional audio. The most common balanced connector is the XLR-type.

The unbalanced system is more susceptible to noise pick up, and it is generally not preferred in professional work. The most common unbalanced connector is the 1/4" phone connector also known as RCA connector.

2. XLR connection, balanced signal

3-pin XLR-cables are used as standard electrical interconnections between professional audio devices. The significance of this interconnection type rests on the so-called "balanced mode". Figure 1 shows the essentials of the balanced signal interconnection. The three XLR pins are assigned as follows:

- 1 - Shield / ground (X)
- 2 - Live (L)
- 3 - Return (R)

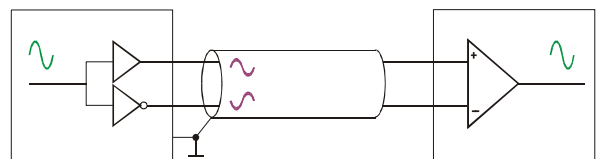

Fig 2.1, balanced mode signal transmission

For a perfect interconnection in balanced mode the two signals "Live" and "Return" - both measured with reference to ground (X) - have to show two characteristics:

- signal amplitude has to be identical
- phase difference between the two has to be 180° degrees.

By subtracting “Return” from “Live” - as performed by the receiver - results at the receiver output will in the transmitted signal with doubled amplitude.

Why do we need two connection paths for one signal?

Let’s see what happens in the case of a perfect balanced signal if external interferences act on the connection path. In most cases interferences affecting the interconnection will couple disturbing signals to “Live” and “Return” being almost identical as well in amplitude as in phase. Subtraction here will cancel out the “same amplitude and same phase” slice of the interferences, only leaving the small rest originated by the difference between “almost identical” and “identical”. So using a perfect balanced connection the signal to noise ratio of the transmitted signal will be recovered even if severe “same amplitude, same phase” interferences act on the transmission line, for example hum originated by a ground loop.



XLR
Input

Fig 2.2, Minilyzer XLR input connector

3. The Signal Balance Measurement

As per our considerations we conclude that balance conditions are of major importance in noisy environments. The measurement results level, signal to noise ratio (S/N), total harmonic distortion plus noise (THD+N) (which is closely related to S/N), even polarity of a signal may be altered considerably with improper balanced connections.

To get a quick idea on the actual balance conditions the ML1 includes signal balance measurement. This is not only applicable to check XLR-connections. Unexpected balance states may also point to improper measurement set-ups as provoked by unsuitable or even broken cables.

Being so important to the signal transmission the signal balance is measured in detail in the BALANCE mode and it is also monitored during Level-, THD+N- and Polarity-measurements.

How does the balance error measurement is accomplished?

To calculate the balance error the ML1 measures amplitudes and signs of “Live”- and “Return”-signals. The detailed calculation is listed in the Appendix.

Example:

- a. “Live”- and “Return”-signal being of same amplitude but opposite in sign -> a signal balance error value of 0% displayed.
- b. “Live” signal amplitude being two times the amplitude of “Return” (i.e. a 6 dB difference) will result in a balance error of 33%.
- c. One signal broken will result in display value near 99.9%.

3. Applications

By the measurement of the signal balance error discrepancies concerning the way of signal transmission or signal generation show up immediately.

a. Example unsymmetrical amplifier

Unbalance can also originate at the source. As an example, “Live”- and “Return”-output stages of an amplifier may produce unsymmetrical voltages. This is no matter of concern as long as the sum of both voltages is same to the perfect symmetric case and as long as phases are unchanged. But attention: at high signal levels the output carrying the greater level may start to clip. So better unsymmetrical should be avoided.

E.g. the level of pin 2 > pin 3 is causing reducing signal levels and loss of sound quality of the outgoing analog audio signal. To determine and localize this problem take the Minilyzer, select the BALANCE mode, and the non-symmetric output will be immediately indicated on the display by signal balance error reading greater than 1%. Is the signal level on pin 3 for example smaller than on pin 2 by half, so a signal balance error of 33% will be indicated by the Minilyzer.

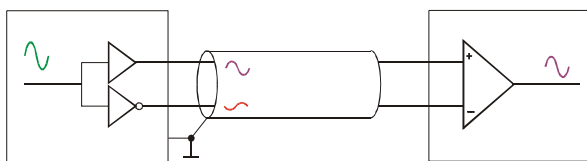

Fig 3.1, amplifier output defective

b. Example impedance match

The balance error may also point you to other imperfections, e.g. different output loads may play in or different output impedances.

If unexpected happens, where's the origin ? The Minilyzer will help you to localize it.

c. Example cable check

You expect a balanced signal, but being in the LEVEL measurement mode the signal balance indicator shows UNBAL indicating a unbalanced signal. Somewhat wondering you switch to BALANCE measurement mode. There you find that signal at pin 2 is much greater than at pin 3 and you read 99.9% balance error.

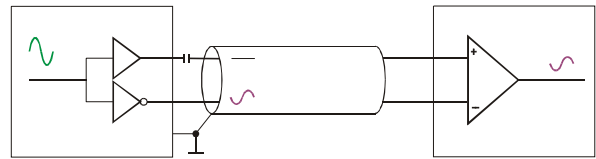

Fig 3.2, cable broken

Explanation ? You might be erroneous in your assumption that the original signal is balanced. Or - you just detected that something goes wrong.

In many cases the cause of the problem is the cable or the connection to the connector. Broken audio cables may be found often in the praxis caused due to ageing, short circuits or external force.

The following figures 3.3 to 3.12 lists level and balance values for some bad cable formations. The test-signal is produced by the NTI Minirator MR1 with a sine-signal selected at 0 dB and 1 kHz. As you can recognize the extent and direction of balance error give a hint which type of cable failure you deal with.

Test setup

Balance

Level

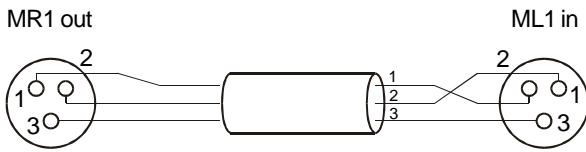

Fig 3.3, wire 1 and 2 crossed

33 %, 2 < 3

-6 dBu

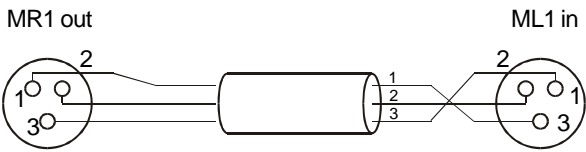

Fig 3.4, wire 1 and 3 crossed

33 %, 2 > 3

-6 dBu

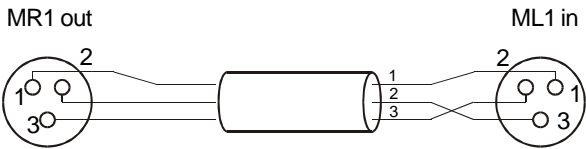

Fig 3.5, wire 2 and 3 crossed

0 %, 2 > 3

0 dBu

(select the MR1 polarity test signal and the ML1 will indicate negative polarity)

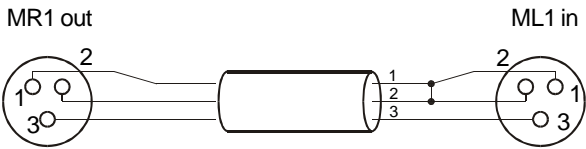

Fig 3.6, wire 1 and 2 shorted

99 - 100 %, 2 < 3

-6 dBu

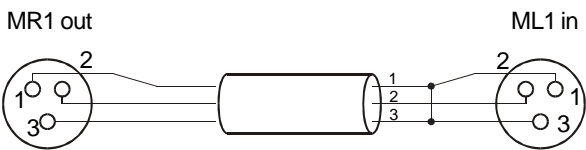

Fig 3.7, wire 1 and 3 shorted

99 - 100 %, 2 > 3

-6 dBu

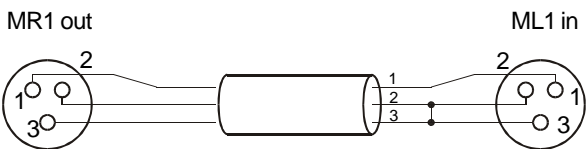

Fig 3.8, wire 2 and 3 shorted

0 %, 2 > 3 or 2 < 3

-90 - 100 dBu

Test setup	Balance	Level
<p>MR1 out</p> <p>ML1 in</p> <p>Fig 3.9, wire 2 broken at ML1 side</p>	99 - 100 %, 2 < 3	-6 dBu
<p>MR1 out</p> <p>ML1 in</p> <p>Fig 3.10, wire 3 broken at ML1 side</p>	99 - 100 %, 2 > 3	-6 dBu
<p>MR1 out</p> <p>ML1 in</p> <p>Fig 3.11, wire 2 broken at MR1 side</p>	98 - 99 %, 2 < 3	-6 dBu
<p>MR1 out</p> <p>ML1 in</p> <p>Fig 3.12, wire 3 broken at MR1 side</p>	98 - 99 %, 2 > 3	-6 dBu

Appendix:

a. User manual signal balance error

In the Level, THD+N and Polarity measurement function (XLR input only), the Milyzer ML1 permanently displays the input signal balance in qualitative terms. The graphical indicator for this measurement is located in the upper right area of the LCD.

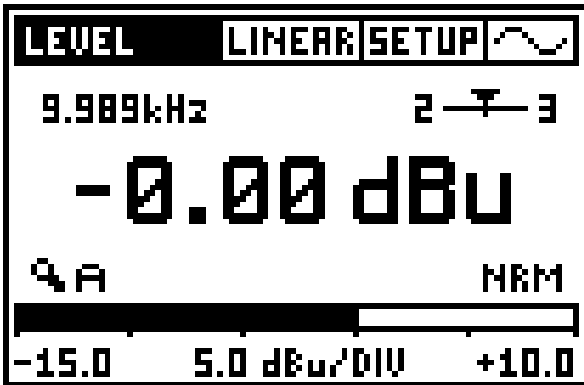

Fig A.1, ML1 screenshot level

This field shows the deviation from level-match of the incoming balanced signal between pin 2 and pin 3 in percent (%). The position of the arrow indicates the following:

- Arrow in center, the input signal is balanced.
- Arrow out of center, linear indication of a balancing problem, e.g. arrow moves left nearer to the number 2 shows the signal level on pin 2 is higher than on pin 3.
- Left or right end, the signal balance error is 33% or higher. 33% equals a difference in the signal level of 6 dB.
- UNBAL, the signal balance symbol changes to UNBAL at the signal balance error exceeding 90%.

For detailed indication the user may select the Balance mode.

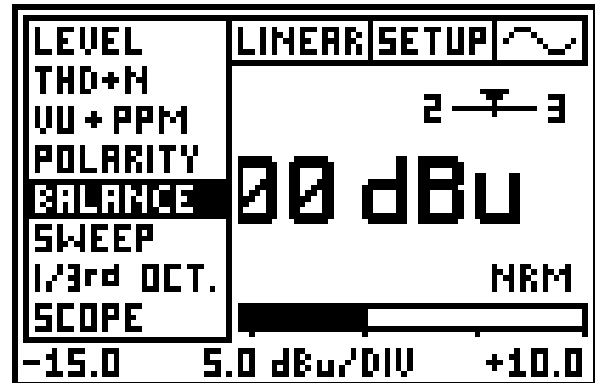

Fig A.2, ML1 screenshot menu

In addition to the permanent indicator, ML1 offers an exact Signal Balance Error measurement. To activate this mode proceed as follows:

- Switch ON the ML1
- Press the enter key to open the measurement functions submenu and select the entry "Balance" by using the cursor keys
- Confirm by pressing the enter key

The signal balance error reflects the deviation from the perfect balance status. No signal balance error indicates that the absolute levels at XLR-pin 2 and pin 3 relative to pin 1 (ground) are identical and opposite in polarity. In the BALANCE mode, the signal balance error is shown in a numerical value, which is the deviation from the optimum in percent.

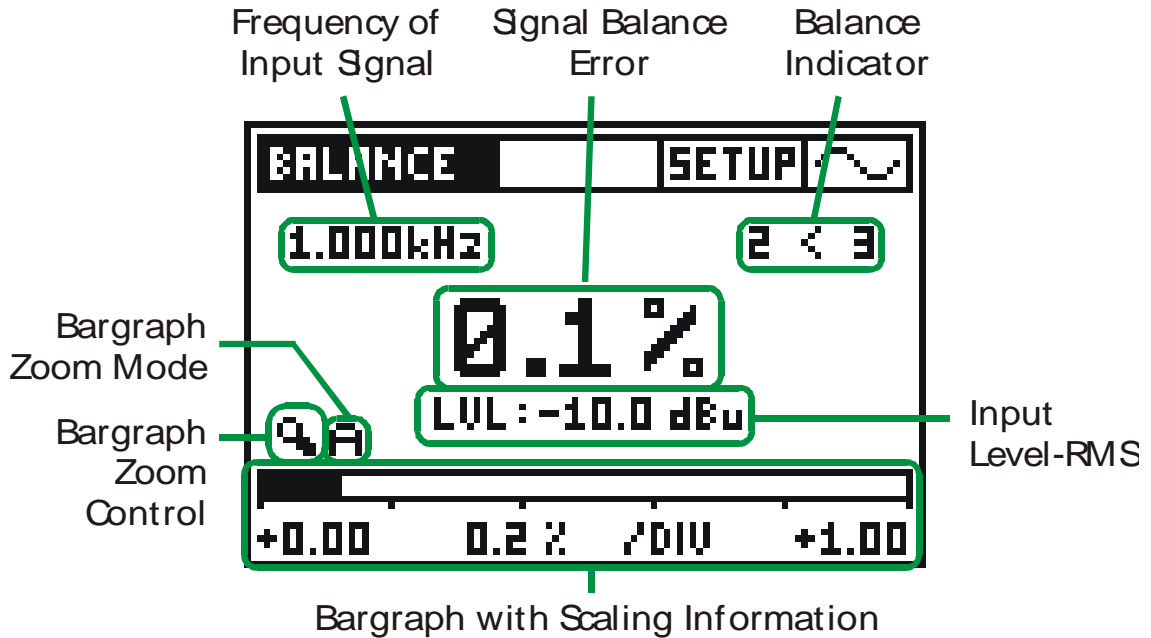

Fig A.3, ML1 screenshot balance menu

Balance Indicator: The direction of the deviation is indicated by the arrows like 2 < 3 or 2 > 3, whereby the numbers 2 and 3 represent the signal at XLR-pin 2 and pin 3. In the Level, THD+N and Polarity (electrical input only) measurement function, the Minilyzer permanently monitors the balance of the input signal by a graphical indicator. This enables e.g. to check whether cable connections are made correctly.

Bargraph: The bargraph shows an analog display of the signal balance error. The scaling may be controlled automatically or manually.

- Select manual (M) or automatic (A) scaling by the bargraph zoom mode field.
- Within the manual scaling press the left/right keys to scroll through the actual range or the up/down keys to increase or decrease the range (sensitivity) of the bargraph scale.
- Press enter to confirm your setting.

b. Calculation of signal balance error

Signal balance error is calculated including the „Value“ and „sign“. U2 is the voltage at pin2, U3 the voltage at pin3 - both voltages are measured relative to pin 1.

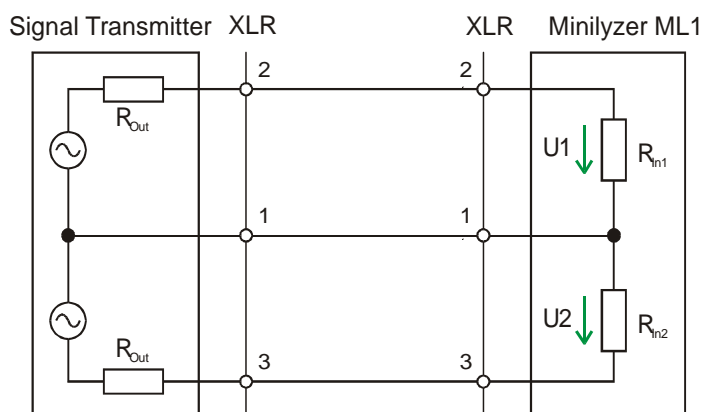

Fig A.4, schematic diagram

$$\text{sign} = |U2| - |U3|$$

Operating the ML1 within BALANCE mode the „Value“ is displayed in % and the „sign“ is indicated as an arrow. In case the level at pin 2 is greater than the level at pin 3 the display will indicate 2>3 .

Balance indication within other measurement modes (Level, THD+N, Polarity) will show a filled triangle shifted from middle position toward the “2”-end of a horizontal line. You may imagine a pair of balances with more weight pushed to the “pin-2”-scale.

Strictly looked into the signal we should not only respect sign but also deviations from 180° phase differences. ML1 assumes that these deviations are small enough to be neglected, an assumption justified for purpose of signal balance measurement.

Measuring Accuracy:

Typically impedances of the ML1-XLR-inputs “Live” and “Return” (relative to ground) are 20 kOhm. But this impedances feature tolerances within +1% and -1% margins. The measuring accuracy of the Minitizer ML1 depends on the impedance of the signal transmitter’s output resistors R_{Out} .

Figure A.5 outlines the error margins of balance error measurement with +/-1% tolerances of ML1 input impedances at equal generator output impedances R_{out} . The margins are calculated assuming a balanced source with equal open-circuit-voltages. This assumption yields the broadest error bounds. As source voltages get more unbalanced, the error margins will be smaller.

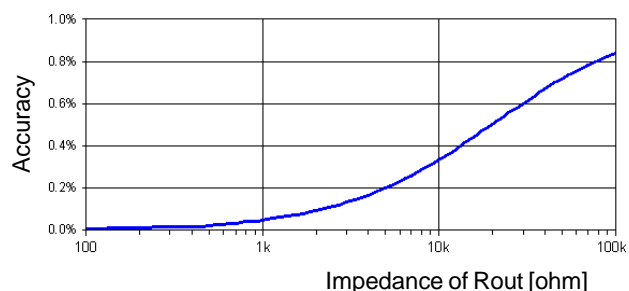

Fig A.5, measurement accuracy

The preceding calculation assumed purely resistive impedances. In reality capacitive loads may play in (inductive components can be neglected for short cable length). This evokes phase shifts.

As pointed out the signal balance error measurement does not include phase measurement, only sign is respected. Anyhow different capacitive loads at pin 2 and pin 3 will show up if significant. Low passes formed by resistors involved and capacitive loads will alter absolute voltage values at pin 2 and pin 3 differently.